

ITW GSE

Illustrated Parts List

3400 PCA 130/2 – CE + UL

Illustrated Part List – 3400 PCA 130/2 – CE + UL
Recommended Spare parts list rev. B

Top view

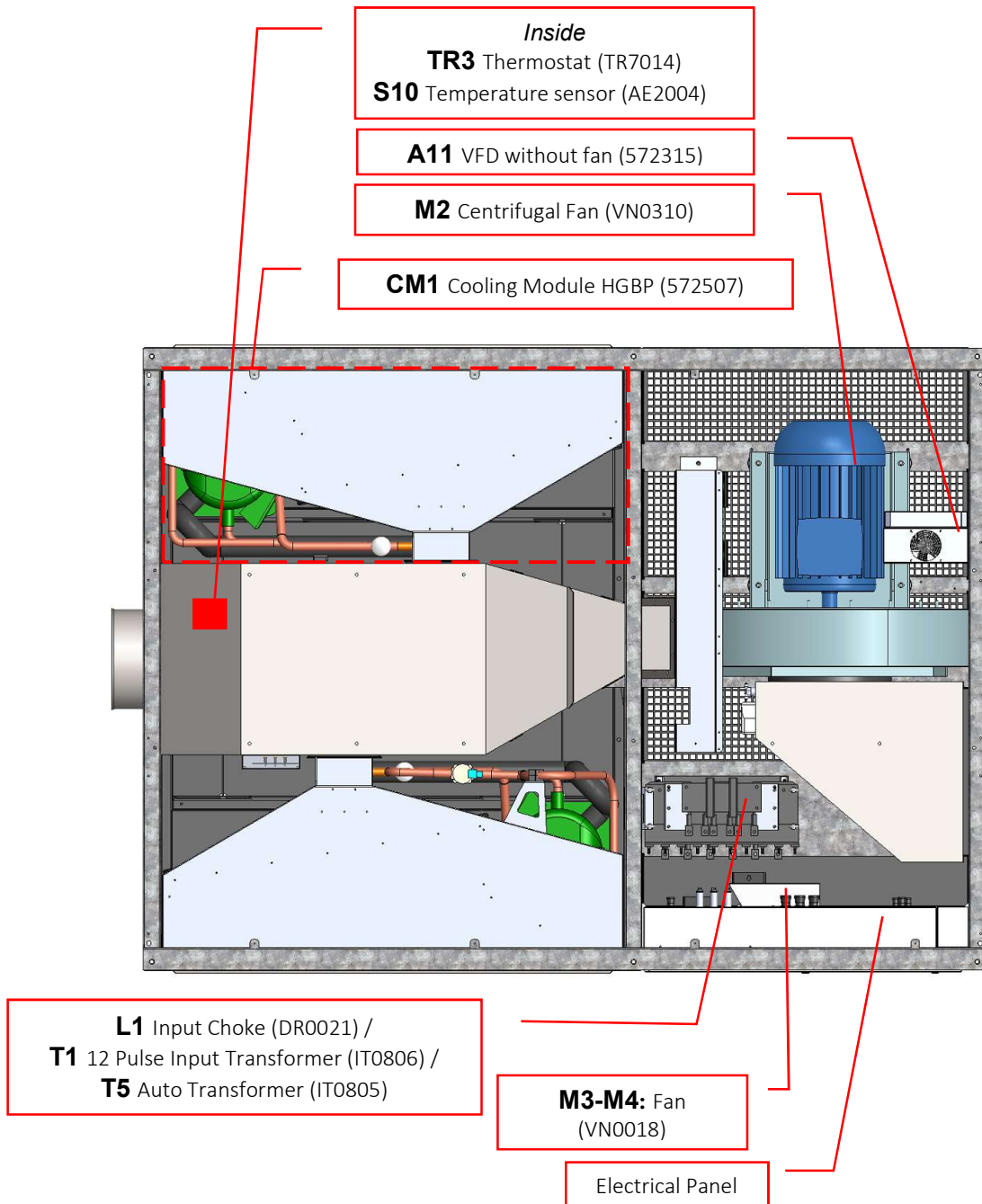

Illustrated Part List – 3400 PCA 130/2 – CE + UL

Recommended Spare parts list rev. B

CE - Front View- Top (Electronic Zone)

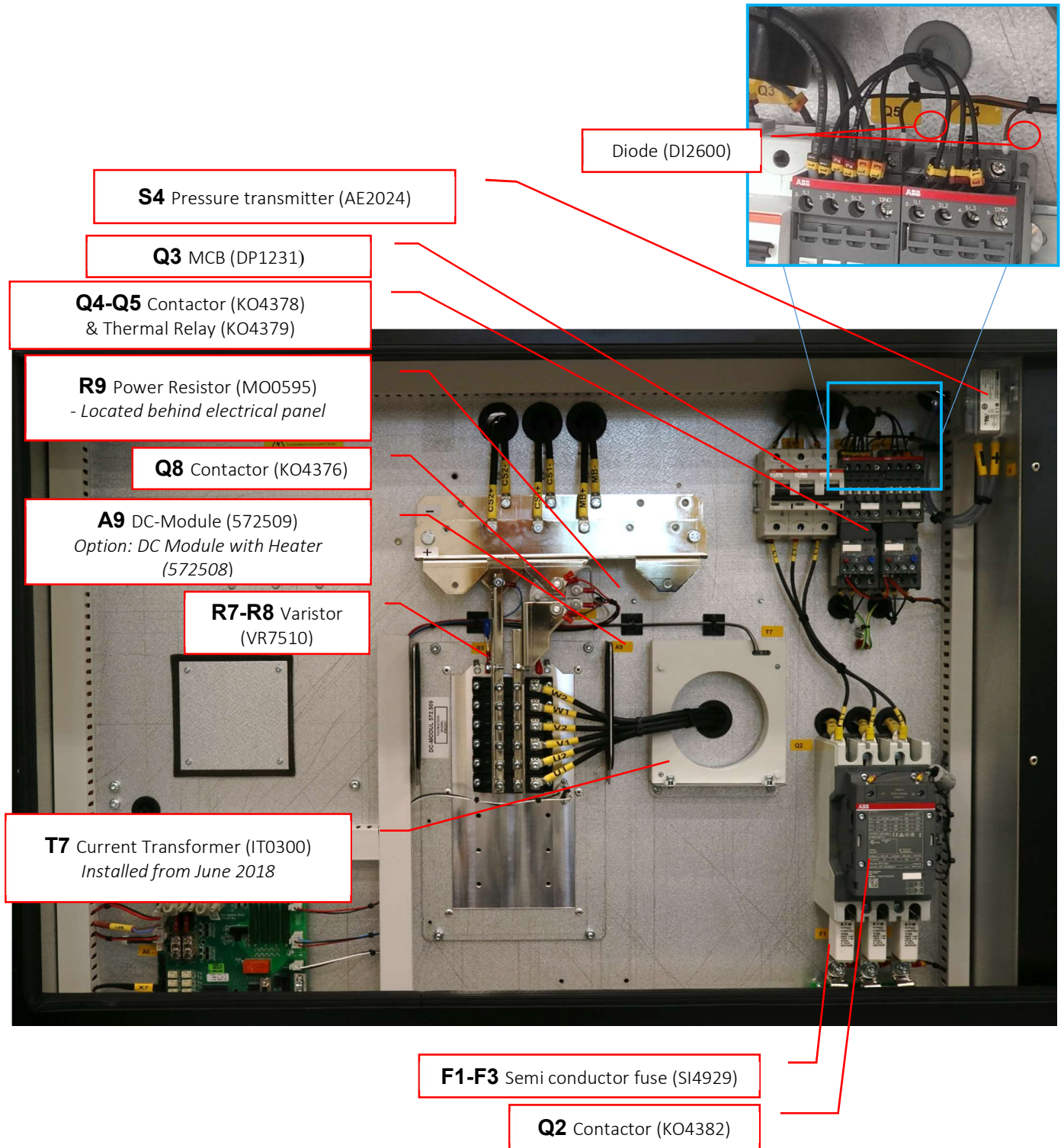

Illustrated Part List – 3400 PCA 130/2 – CE + UL
Recommended Spare parts list rev. B

UL - Front View- Top (Electronic Zone)

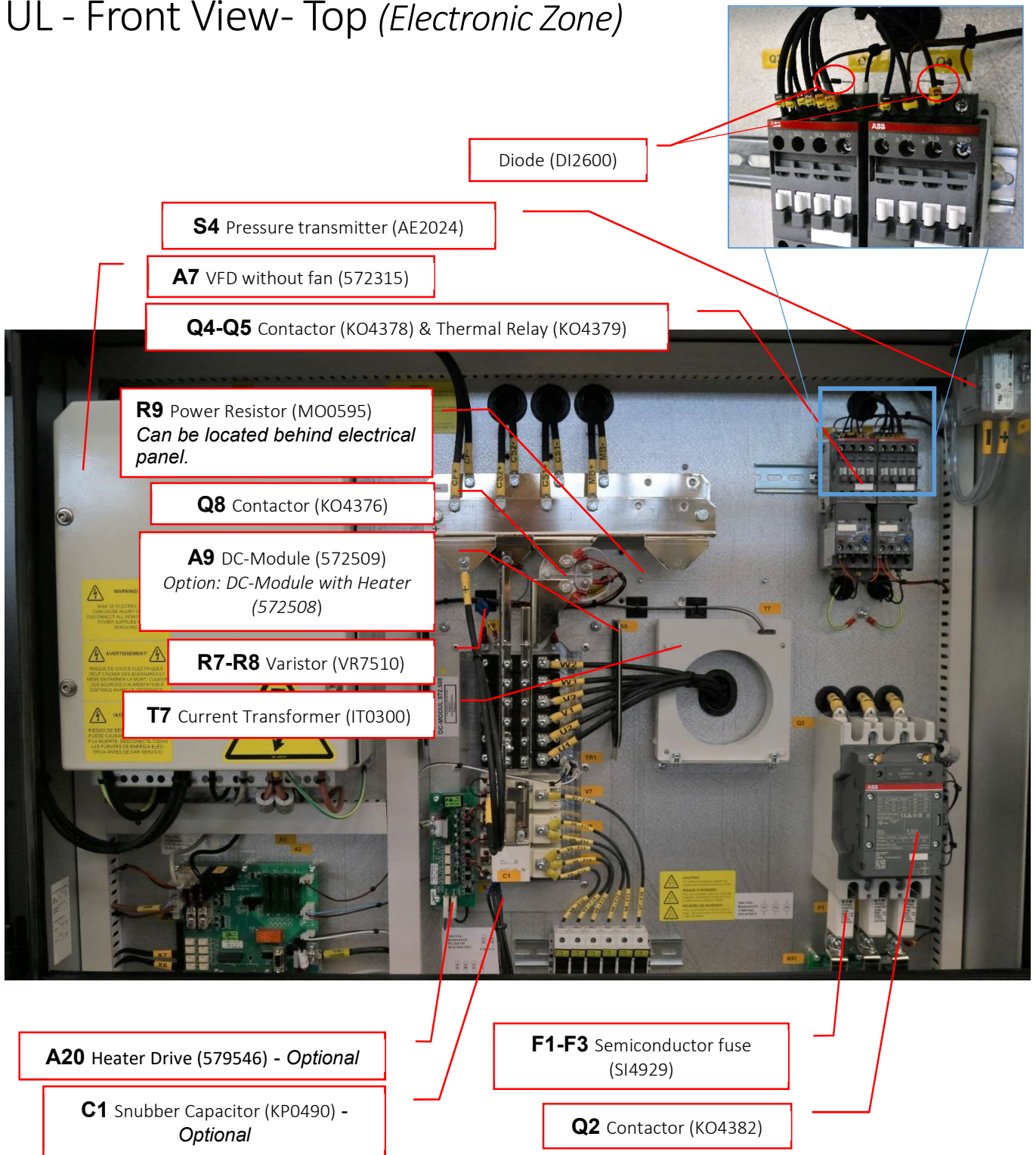

Illustrated Part List – 3400 PCA 130/2 – CE + UL
Recommended Spare parts list rev. B

Front View – Bottom (*Electronic Zone*)

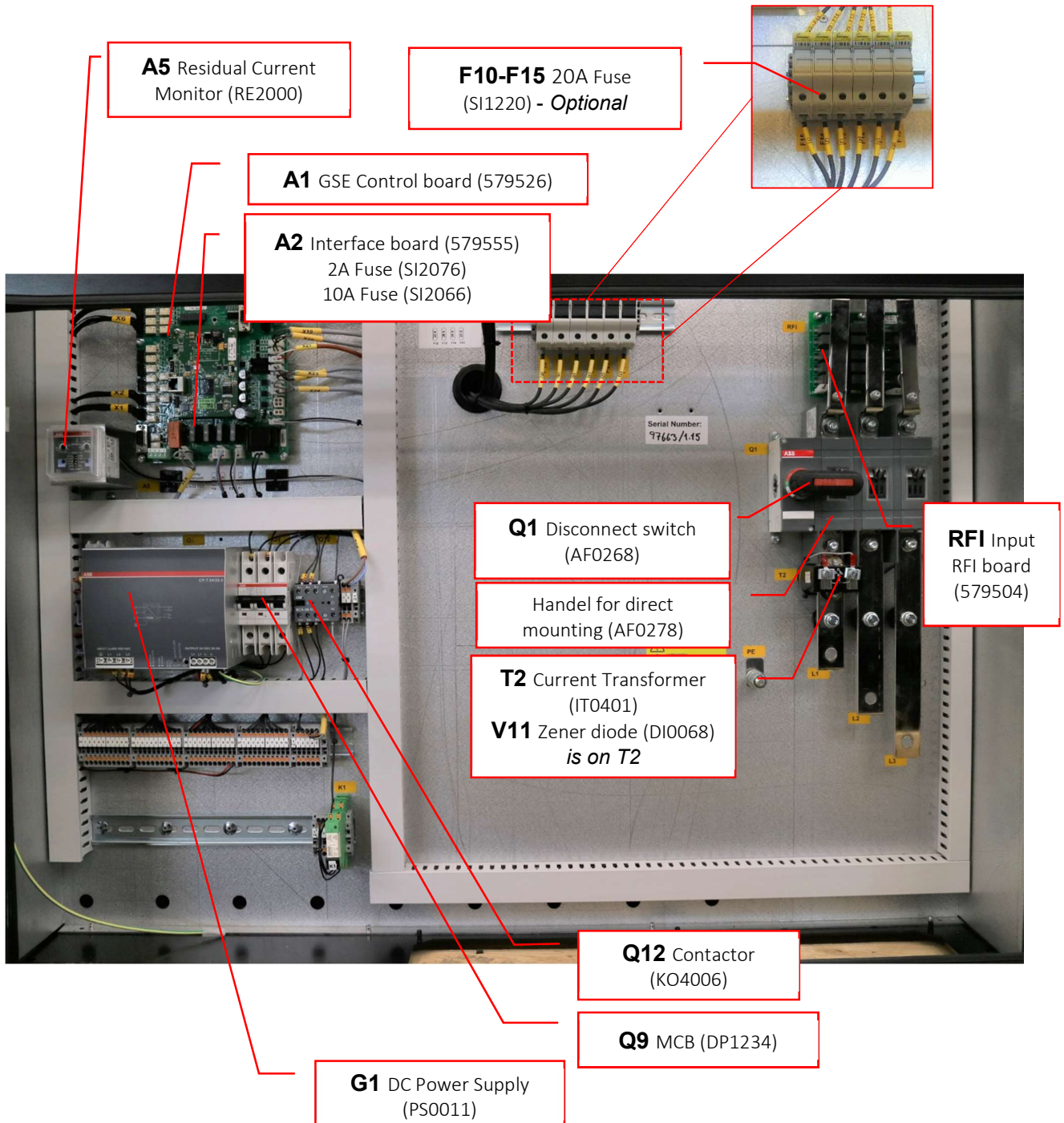

Illustrated Part List – 3400 PCA 130/2 – CE + UL
Recommended Spare parts list rev. B

Complete cooling module

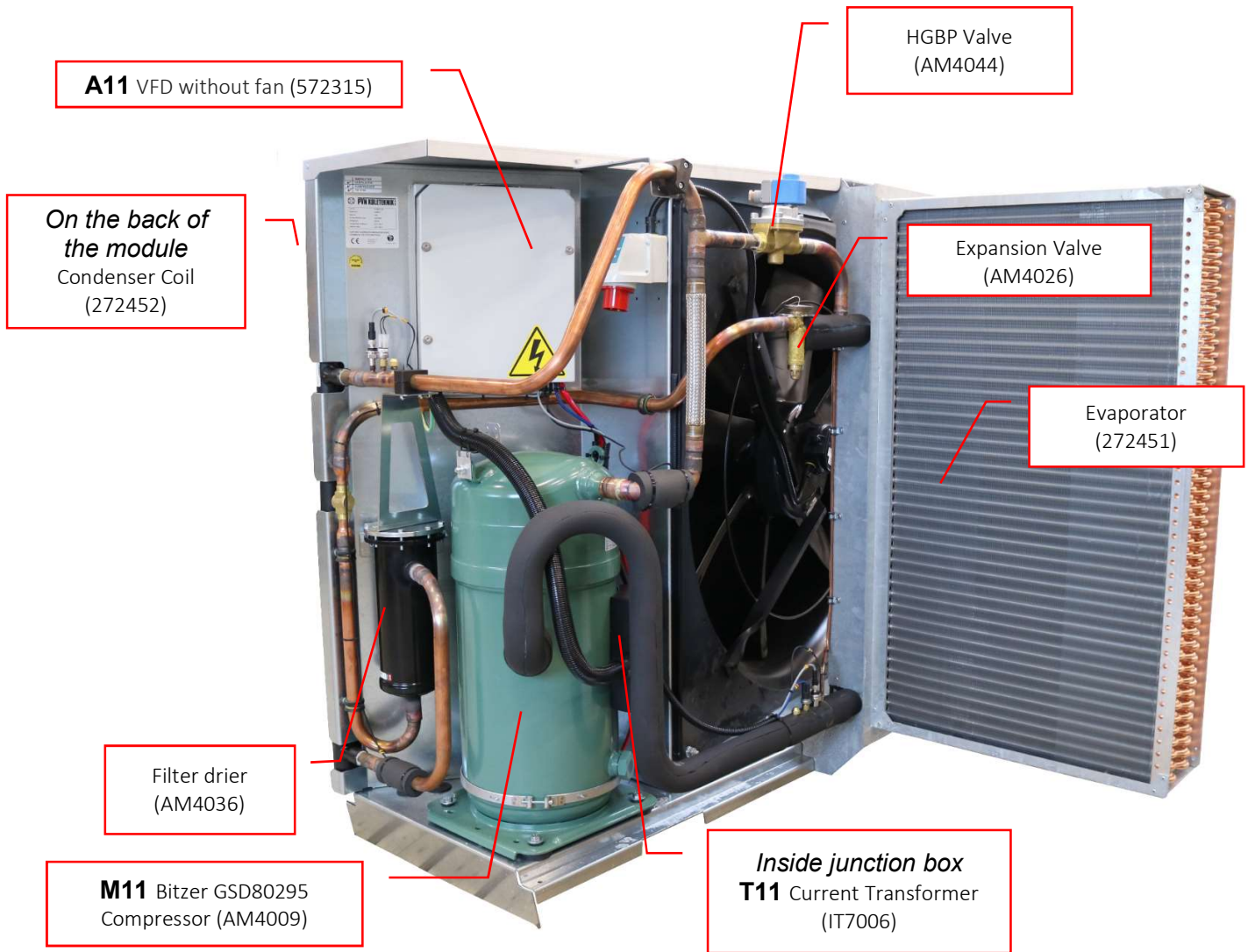

Illustrated Part List – 3400 PCA 130/2 – CE + UL

Recommended Spare parts list rev. B

Complete cooling module- *continued*

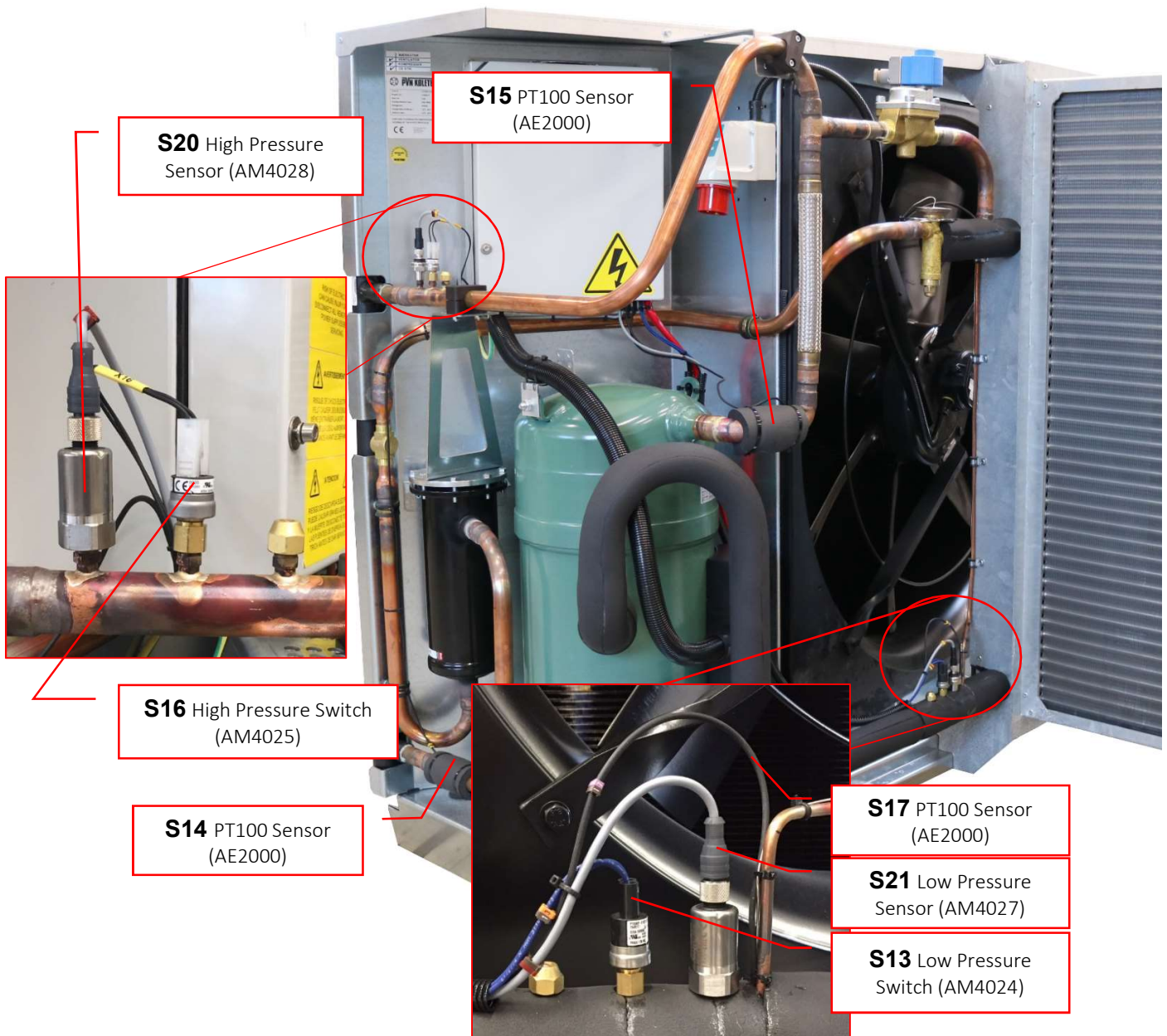

Illustrated Part List – 3400 PCA 130/2 – CE + UL
Recommended Spare parts list rev. B

Main Blower

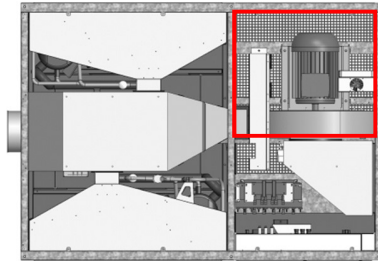

M2 Centrifugal Fan (VN0310)
(Inside is **T6** Current Transformer–
IT7005 for CE and IT7006 for UL)

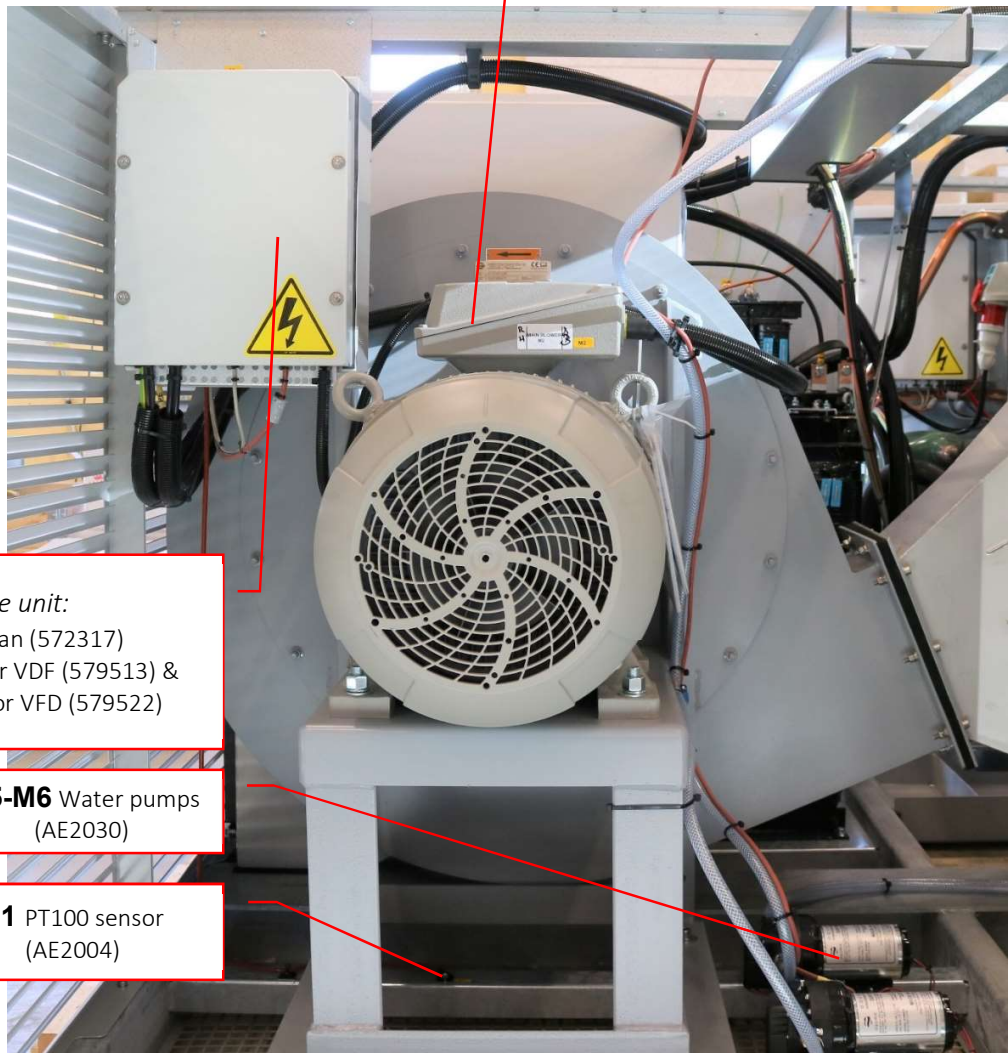

Complete unit:
A8 VFD with fan (572317)
Inside: Gatedrive for VDF (579513) &
Processor board for VFD (579522)

M5-M6 Water pumps
(AE2030)

S1 PT100 sensor
(AE2004)

Illustrated Part List – 3400 PCA 130/2 – CE + UL
Recommended Spare parts list rev. B

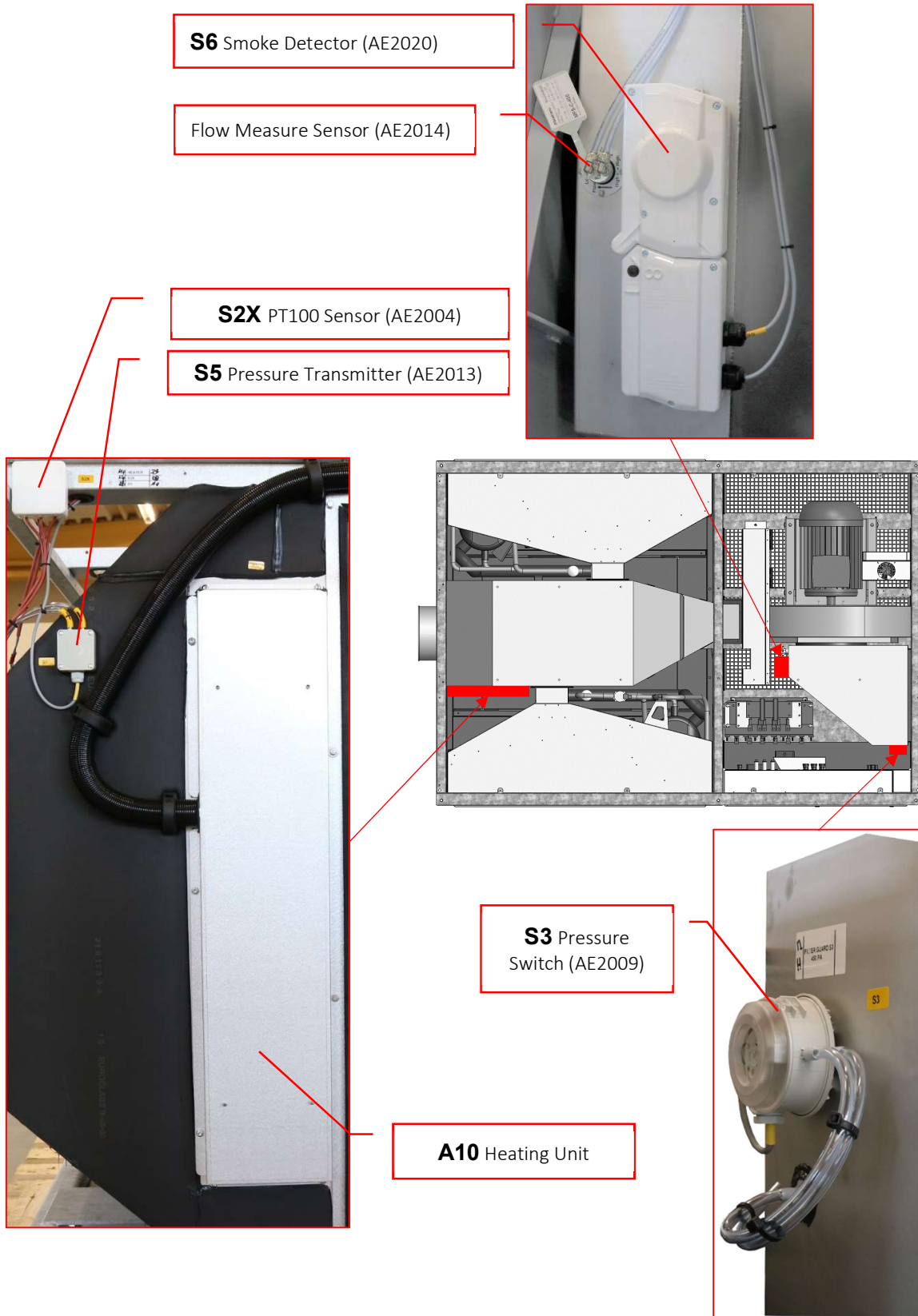

Illustrated Part List – 3400 PCA 130/2 – CE + UL
Recommended Spare parts list rev. B

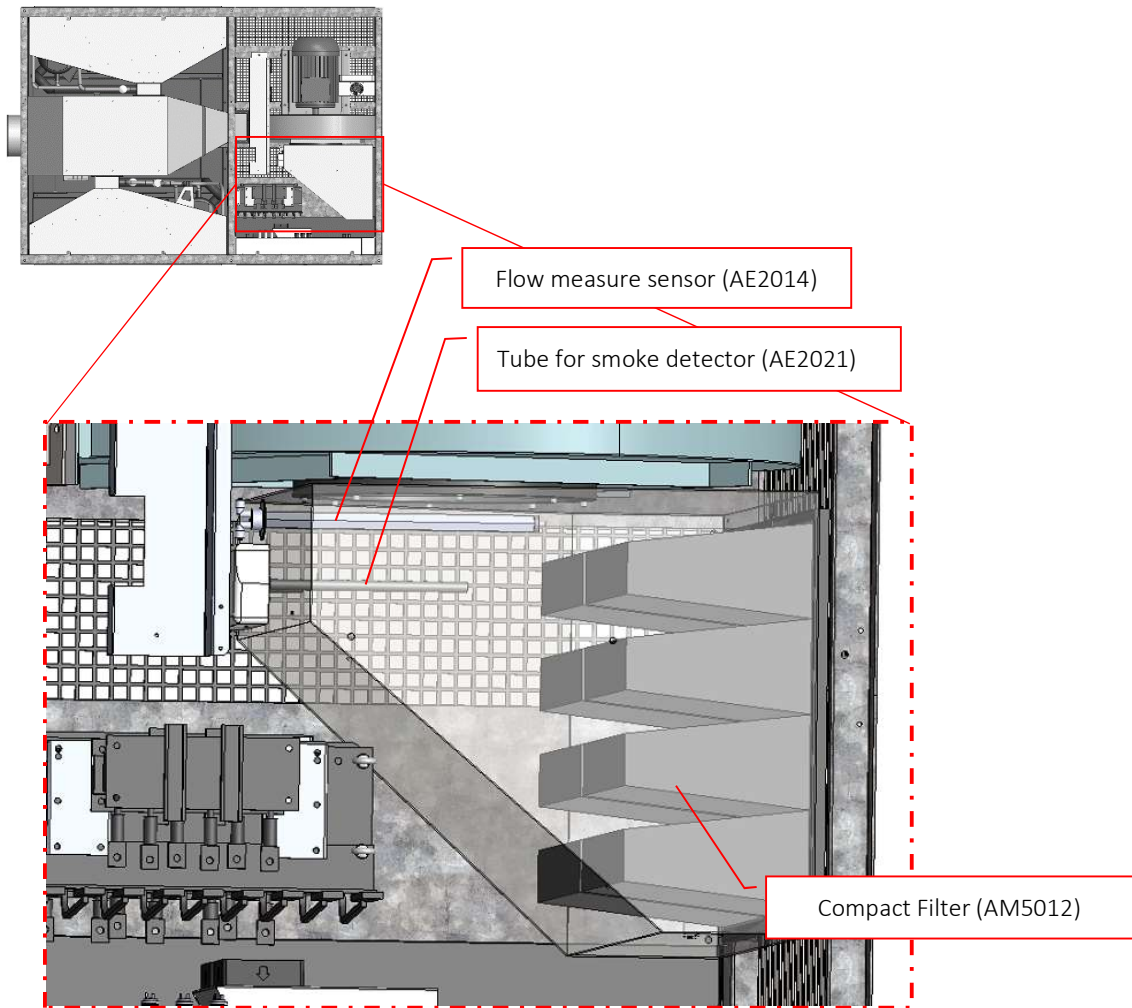

Remote Control Box - 572815



Illustrated Part List – 3400 PCA 130/2 – CE + UL
Recommended Spare parts list rev. B

Remote Control Box - inside

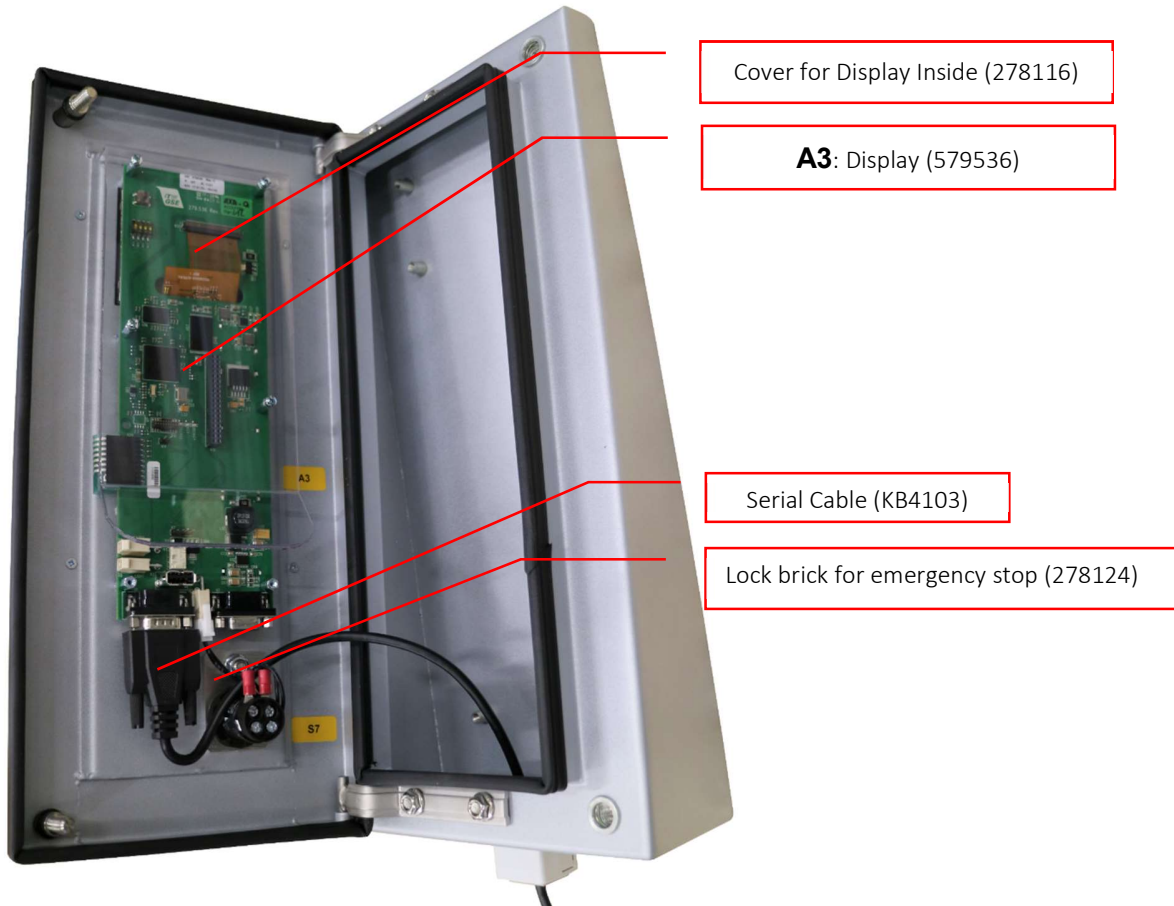

Optional Component Cabin Sensor – (572810)

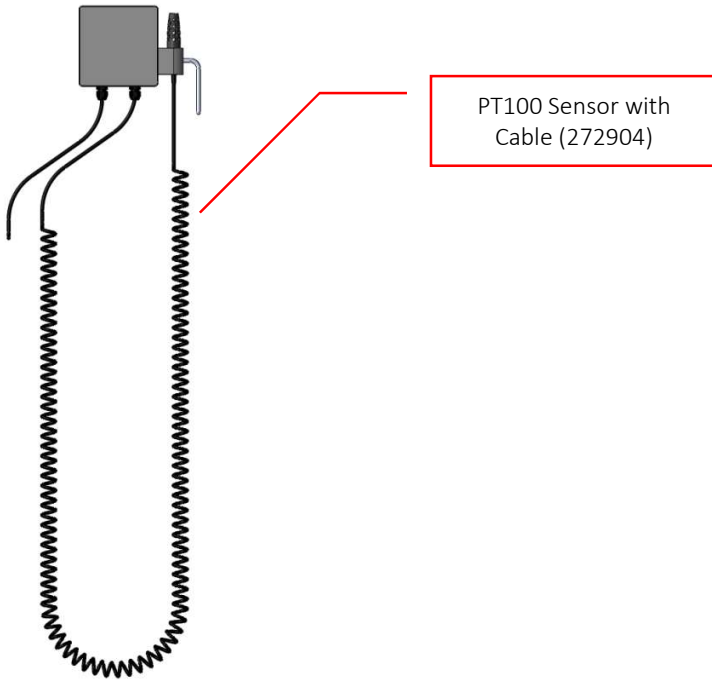

Additional options

- | | |
|--------|---|
| 572812 | Feet for Apron Mounting |
| 572813 | Extended Cable for Remote box |
| 572825 | RS485 Interface |
| 578816 | ITW GSE Service Tool – PC software (578816) |